

REGOLATORE

- * Membrana a rotolamento.
- * Stabilità della pressione regolata indipendentemente dalle variazioni a monte.
- * Grande portata con basse perdite di carico.
- * Rapida eliminazione delle sovrappressioni a valle.
- * Scarico della sovrappressione (relieving) incorporato.
- * Pomello con dispositivo di bloccaggio della regolazione.
- * Possibilità di fissaggio a parete utilizzando le staffe predisposte.
- * Campi di pressione:
0-4 Bar, 0-8 Bar (standard), 0-12,5 Bar
0-0,4 MPa, 0-0,8 MPa (standard), 0-1,25 MPa
- * Pressione massima d'ingresso: 12,5 Bar (1,25 MPa).
- * Range di temperatura: 5+50°C (41+122°F).
- * Coppia di serraggio max. inserti G1" IN-OUT: 80 N·m.
- * Peso: 1,721 Kg.

REGULATOR

- * Rolling diaphragm.
- * The set pressure is kept stable regardless of upstream variations.
- * High flow rate with low load losses.
- * Downstream overpressure quickly eliminated through relieving.
- * Lockable safety knob.
- * Can be wall mounted using the relative brackets.
- * Pressure ranges:
0-4 Bar, 0-8 Bar (standard), 0-12,5 Bar
0-0,4 MPa, 0-0,8 MPa (standard), 0-1,25 MPa
- * Maximum inlet pressure: 16 Bar (1,60 MPa).
- * Temperature range: 5+50°C (41+122°F).
- * Max. torque inserts G1" IN-OUT: 80 N·m.
- * Weight: 1,721 Kg.

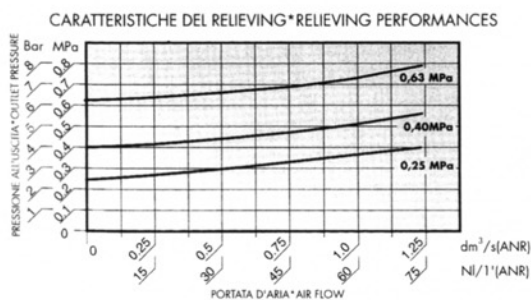
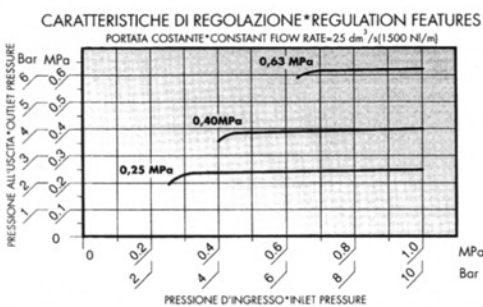
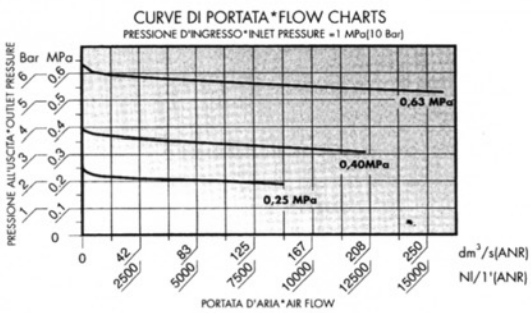

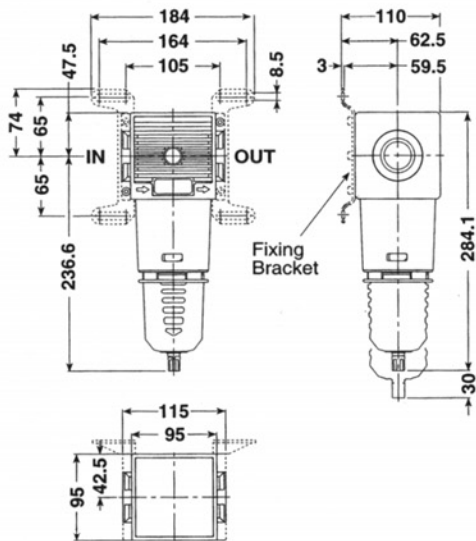

VERSIONE SS
SS VERSION



VERSIONE SA
SA VERSION

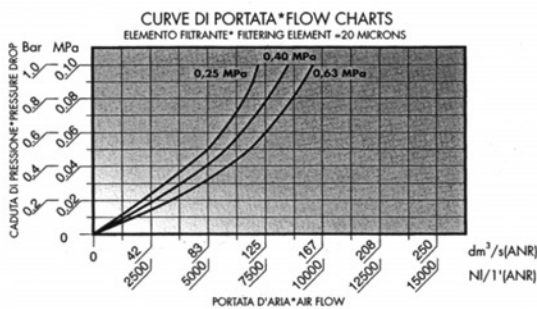
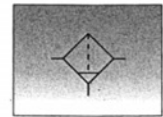

FILTRO

- * Elevato livello di separazione della condensa.
- * Bassa caduta di pressione.
- * Possibilità di fissaggio a parete utilizzando le staffe predisposte.
- * Aggancio rapido della tazza con meccanismo di sicurezza antiespulsione.
- * Grado di filtrazione: 5 micron e 20 micron (standard).
- * Dispositivo di drenaggio della condensa manuale e semiautomatico in versione integrata (SS).
- * Disponibile nella versione SA con scarico automatico a galleggiante, in grado di drenare automaticamente all'esterno del contenitore la condensa, anche in presenza di pressione.
- * Tazza in poliammide tenacizzata con protezione esterna.
- * Quantità di condensa raccolta: 200 cc.
- * Pressione massima d'esercizio: 12,5 Bar (1,25 MPa).
- * Range di temperatura: 5+50°C (41+122°F).
- * Coppia di serraggio max. inserti G1" IN-OUT: 80 N-m.
- * Peso: 1,212 Kg.

FILTER

- * High condensate separation level.
- * Low pressure drop.
- * Can be wall mounted using the relative brackets.
- * Quick bowl connection by means of safety ring mechanism.
- * Filtering degree: 5 micron and 20 micron (standard).
- * Manual and semiautomatic condensate drainage in the integrated (SS) or float type automatic version (SA).
- * Bowl in toughened polyamide with outer bowl guard.
- * Collected quantity of condensate: 200 cc.
- * Maximum operating pressure: 12,5 Bar (1,25 MPa).
- * Temperature range: 5+50°C (41+122°F).
- * Max. torque inserts G1" IN-OUT: 80 N-m.
- * Weight: 1,212 Kg.

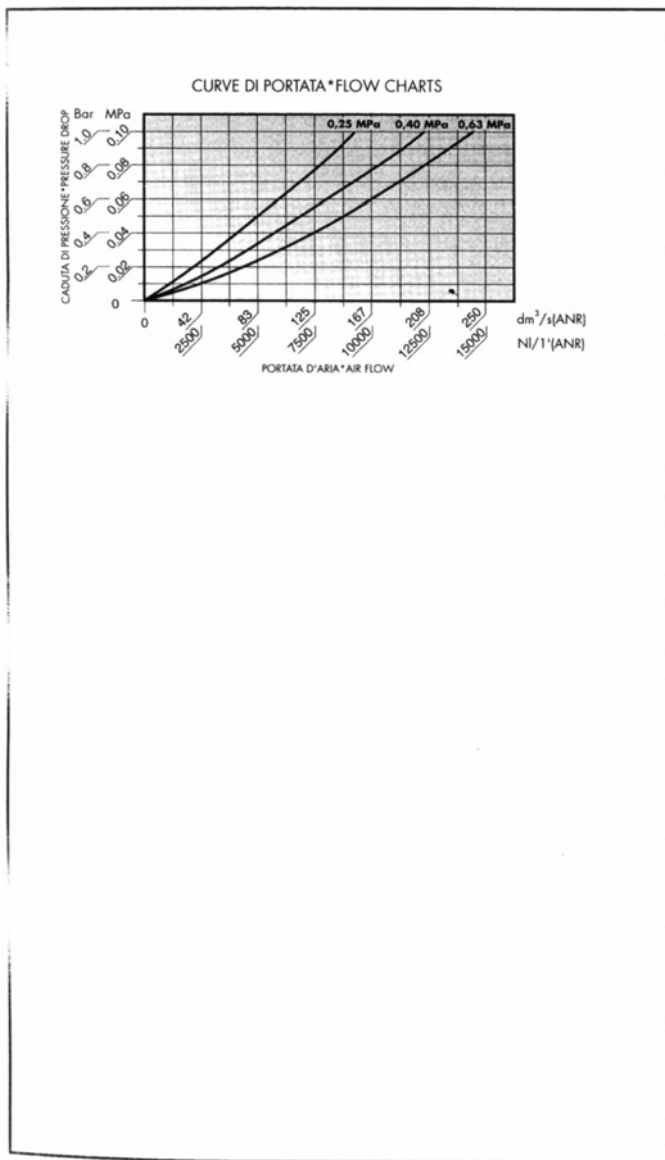
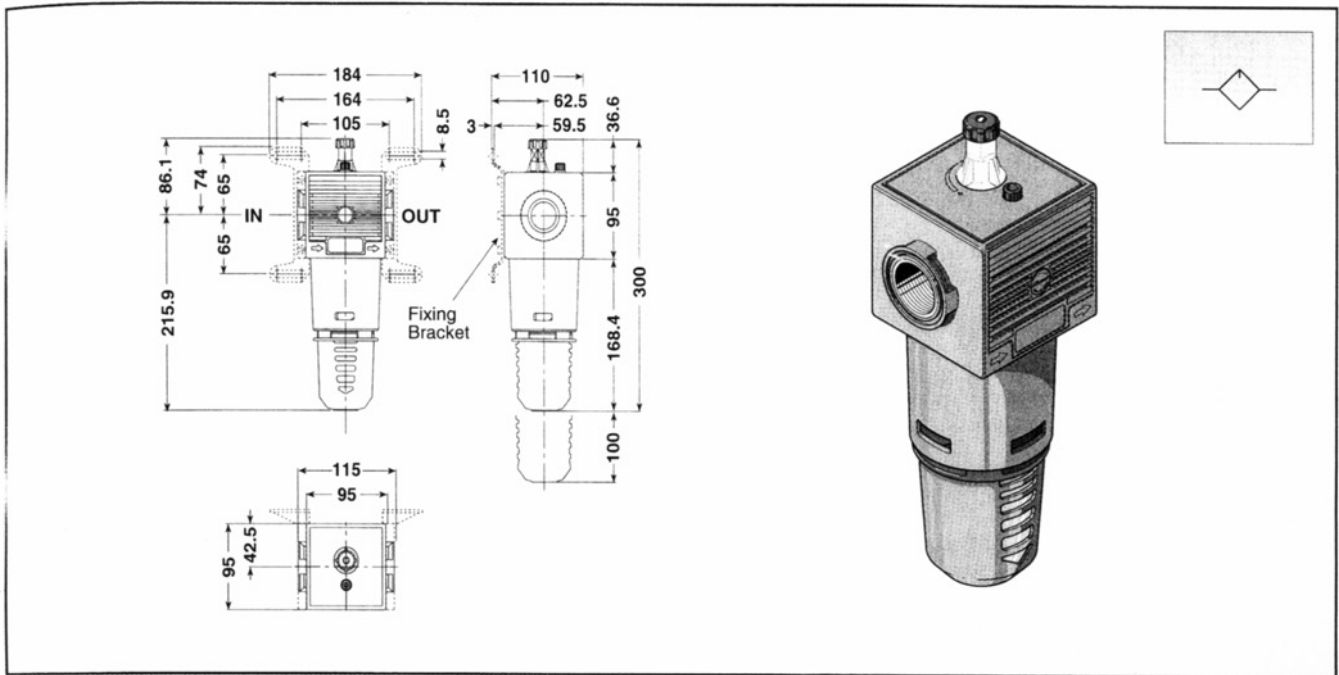

LUBRIFICATORE

- Di tipo proporzionale a nebbia d'olio.
- * Erogazione costante nel tempo.
- * Pescaggio assicurato anche con basse portate.
- * Regolazione sensibile della quantità di lubrificante.
- * Visualizzazione del gocciolamento a 360°.
- * Tappo di caricamento olio.
- * Aggancio rapido della tazza con meccanismo di sicurezza antiespulsione.
- * Possibilità di fissaggio a parete utilizzando le staffe predisposte.
- * Tazza in poliammide tenacizzata con protezione esterna.
- * Capacità tazza: 440 cc.
- * Viscosità olio consigliata ISO VG32.
- * Pressione massima d'esercizio: 12,5 Bar (1,25 MPa).
- * Range di temperatura: 5+50°C (41+122°F).
- * Coppia di serraggio max. inserti G1" IN-OUT: 80 N-m.
- * Peso: 1,194 Kg.

LUBRICATOR

- Proportional oil mist type.
- * Constantly steady delivery.
- * Suction ensured even at low flow rates.
- * Sensitive lubricant flow regulation.
- * 360° drip display.
- * Oil fill plug.
- * Quick bowl connection by means of safety ring mechanism.
- * Can be wall mounted using the relative brackets.
- * Bowl in toughened polyamide with outer bowl guard.
- * Bowl capacity: 440 cc.
- * Recommended oil viscosity ISO VG32.
- * Maximum operating pressure: 12,5 Bar (1,25 MPa).
- * Temperature range: 5+50°C (41+122°F).
- * Max. torque inserts G1" IN-OUT: 80 N-m.
- * Weight: 1,194 Kg.

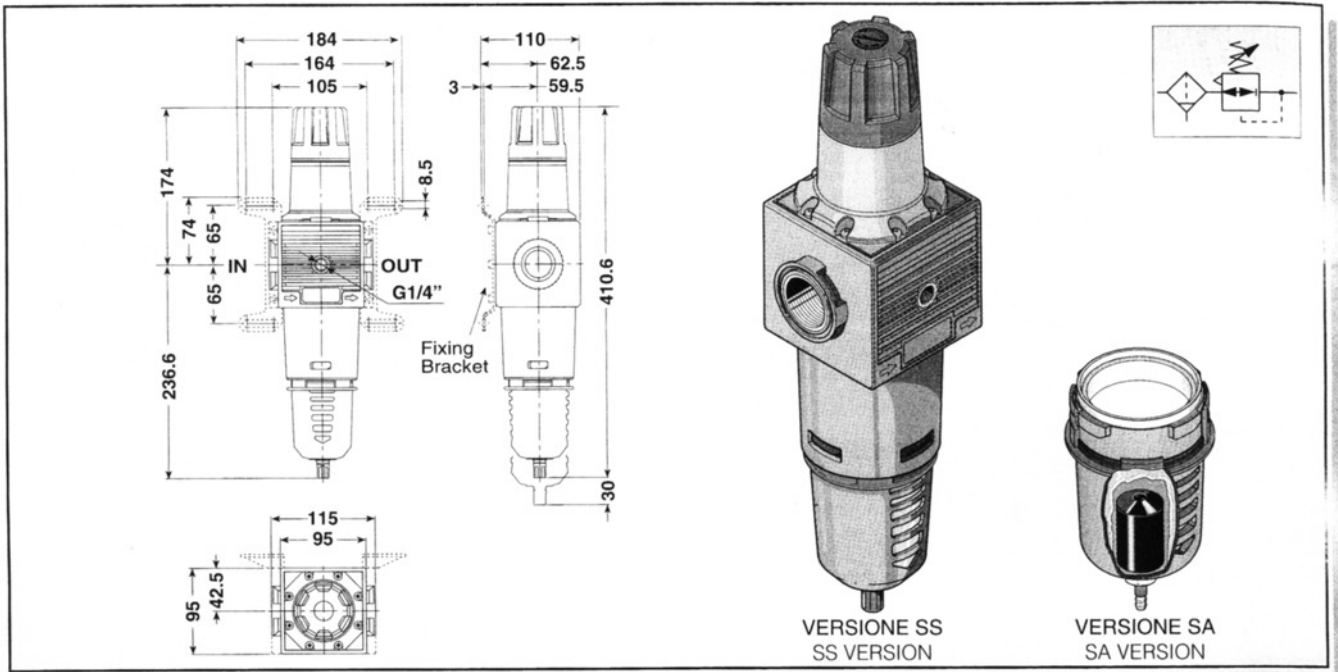

VERSIONE SS
SS VERSION

VERSIONE SA
SA VERSION

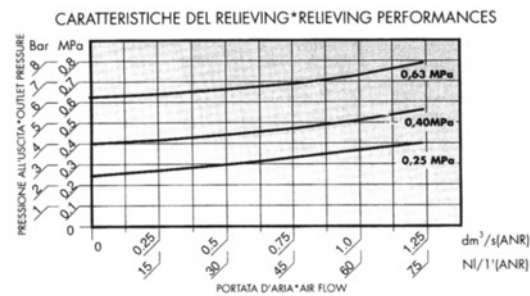
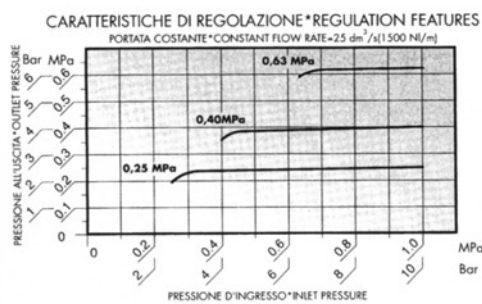
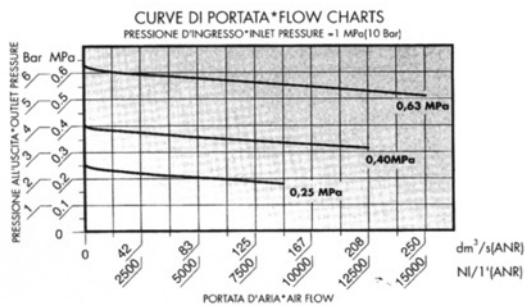

FILTRO REGOLATORE

- * Membrana a rotolamento.
- * Stabilità della pressione regolata indipendentemente dalle variazioni a monte.
- * Scarico della sovrappressione (relieving) incorporato.
- * Pomello con dispositivo di bloccaggio della regolazione.
- * Elevato livello di separazione della condensa.
- * Possibilità di fissaggio a parete utilizzando le staffe predisposte.
- * Campi di pressione:
0-4 Bar, 0-8 Bar (standard), 0-12,5 Bar
0-0,4 MPa, 0-0,8 MPa (standard), 0-1,25 MPa
- * Grado di filtrazione: 5 micron e 20 micron (standard).
- * Dispositivo di drenaggio della condensa manuale e semi-automatico in versione integrata (SS) o scarico automatico (SA).
- * Tazza in poliammide tenacizzata con protezione esterna, munita di aggancio rapido con sicurezza antiespulsione.
- * Quantità di condensa raccolta: 200 cc.
- * Pressione massima d'esercizio: 12,5 Bar (1,25 MPa).
- * Range di temperatura: 5+50°C (41+122°F).
- * Coppia di serraggio max. inserti G1" IN-OUT: 80 N-m.
- * Peso: 2,060 Kg.

FILTER REGULATOR

- * Rolling diaphragm.
- * The set pressure is kept stable regardless of upstream variations.
- * Built-in overpressure relieving function.
- * Lockable safety knob.
- * High condensate separation level.
- * Bowl in toughened polyamide with outer bowl guard and quick connection by means of safety ring mechanism.
- * Can be wall mounted using the relative brackets.
- * Pressure ranges:
0-4 Bar, 0-8 Bar (standard), 0-12,5 Bar
0-0,4 MPa, 0-0,8 MPa (standard), 0-1,25 MPa
- * Filtering degree: 5 micron and 20 micron (standard).
- * Manual and semiautomatic condensate drainage in the integrated (SS) or float type automatic version (SA).
- * Collected quantity of condensate: 200 cc.
- * Maximum operating pressure: 12,5 Bar (187 Psi)(1,25 MPa).
- * Temperature range: 5+50°C (41+122°F).
- * Max. torque inserts G1" IN-OUT: 80 N-m.
- * Weight: 2,060 Kg.

ACCESSORI E RICAMBI LINEA 095
SPARE PARTS LINE 095



GRUPPO SUPERIORE REGOLATORE
REGULATION GROUP

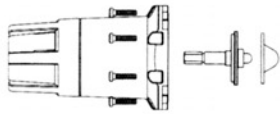

CODE	PRODUCT
C95.01.00017	R - FR

GRUPPO MEMBRANA COMPLETO
DIAPHRAGM COMPLETE



CODE	PROD.	VERSION
C95.01.00005	R - FR	RELIEVING

MOLLA REGOLAZIONE
REGULATION SPRING



CODE	PROD.	SET.REGULATION
A95.01.00016	R - FR	0-4 Bar
A95.01.00017	R - FR	0-8 Bar
A95.01.00018	R - FR	0-12 Bar

TAZZA COMPLETA PER FILTRO
BOWL FOR FILTER

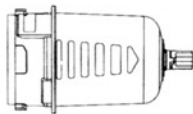

CODE	PROD.	VERSION
C95.02.00005	F-FR	PE-SS

TAZZA CON SCARICO AUTOMATICO
BOWL WITH AUTOMATIC DRAIN

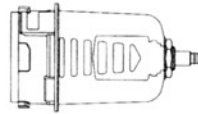

CODE	PROD.	VERSION
C95.02.00006	F-FR	PE-SA

TAZZA COMPLETA PER LUBRIFICATORE
BOWL FOR LUBRICATOR



CODE	PROD.	VERSION
C95.03.00004	L	PE

GRUPPO FILTRAGGIO
FILTERING ELEMENT



CODE	PROD.	VERSION
C95.02.00003	F	20 MICRON
C95.02.00007	FR	20 MICRON
C95.02.00008	F	5 MICRON
C95.02.00009	FR	5 MICRON

TAPPO COMPLETO DI VALVOLA
PLUG WITH VALVE

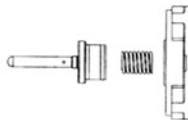

CODE	PRODUCT
C95.01.00019	R - FR

TAPPO OLIO CON OR 2031
OIL PLUG WITH OR 2031



CODE	PRODUCT
C75.03.00011	L

TUBO ASPIRAZIONE COMPLETO
SUCTION PIPE



CODE	PRODUCT
C95.03.00005	L

SCARICO AUTOMATICO
AUTOMATIC DRAIN

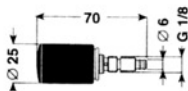

CODE	PRODUCT
C40.02.00130	F - FR

KIT MONTAGGIO SCARICO AUTOMATICO
MOUNTING KIT FOR AUTOMATIC DRAIN



CODE	PRODUCT
C40.02.00131	F - FR

CUPOLA SPIA COMPLETA
OIL WINDOW

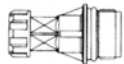

CODE	PRODUCT
C75.03.00018	L

KIT PER ASSEMBLAGGIO GRUPPI
KIT ASSEMBLING UNITS

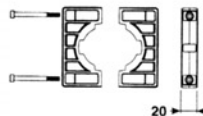

CODE	PRODUCT
C95.05.00001	FR+R+L
C95.06.00001	FR+L-F+L

KIT DI STAFFAGGIO
WALL FIXING KIT

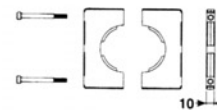

CODE	PRODUCT
C95.01.00015	R - F - L - FR

MANOMETRO
GAUGE

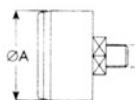

CODE	Bar	Psi	A	B	CH
C95.01.00026	0-12	0-175	63	1/4"	14

STAFFA DI FISSAGGIO A PARETE
BRACKET

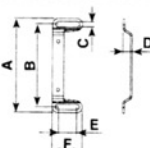

CODE	A	B	C	D	E	F
C95.01.00018	148	130	8.5	15	29.5	47.5