

Equal Ended Bulkhead Coupling, Metric

Wade



Features & Benefits

- In-line configuration
- Enables connection of two tubes of the same outside diameter
- Designed to connect tubes on either side of a bulkhead panel
- Provided with a simple locknut mechanism the fitting can be secured and locked in place through the panel

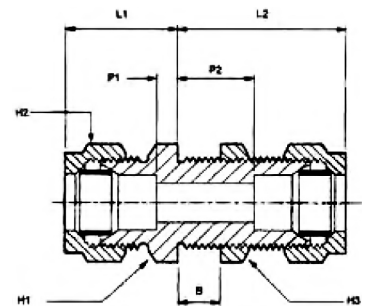

Part No	Tube OD	L1 Length	L2 Length	H1 Hex A/F	H2 Hex A/F	H3 Hex A/F	P1 Abutment	P2 Abutment	B Max Bulkhead	Bulkhead Hole Dia
WADE-MB106/L10	6	20mm	30mm	12mm	12mm	12mm	6.5mm	16.5mm	10mm	11mm
WADE-MB108/L10	8	22.5mm	31.5mm	14mm	14mm	14mm	7.5mm	16.5mm	10mm	13mm
WADE-MB110/L10	10	24mm	33.5mm	19mm	19mm	19mm	9mm	18.5mm	10mm	17mm
WADE-MB112/L12	12	25.5mm	34mm	22mm	22mm	22mm	10mm	18.5mm	10mm	19mm
WADE-MB115/L10	15	33mm	40.5mm	24mm	24mm	24mm	12.5mm	20mm	10mm	21mm
WADE-MB122/L12	22	36.5mm	46.5mm	36mm	36mm	36mm	14mm	24mm	12mm	31mm