



EL-1502, EL-1506

**EL-SERIES**  
SINGLE ACTING,  
LOCK NUT CYLINDERS

► **Features**

- ◆ Safety Lock Nut for mechanical load holding.
- ◆ High flow EAB-201 quick coupler.
- ◆ Overflow port functions as a stroke limiter.
- ◆ Environmentally friendly painting process provides a durable corrosion resistant finish.



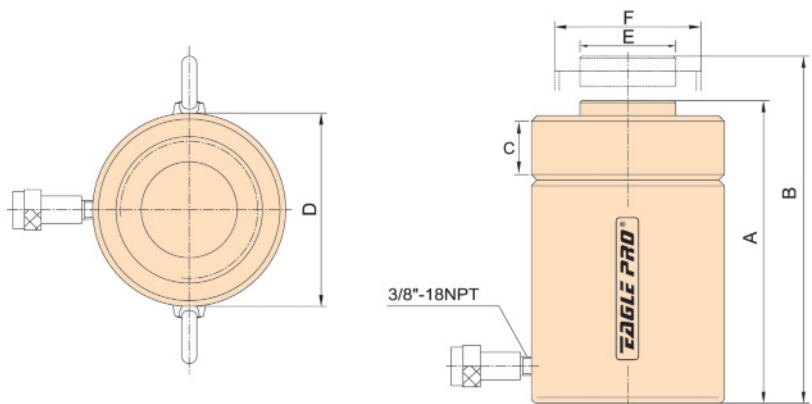

400 ton EAGLE PRO EL series hydraulic cylinders used in bridge building





# EL-SERIES



Quality pressure hoses

Pressure gauges available to monitor system pressure

Optional tilting and threaded saddles available



Cylinder Capacity @700bar	Stroke	Model	Cylinder Effective Area	Oil Capacity	Collapsed Height	Extended Height	Lock Nut height	Outside Diameter	Sandle diam.	Piston Diam	Weight
			Advance	Advance	A	B	C	D	E	F	
ton	in		in <sup>2</sup>	in <sup>3</sup>	in	in	in	in	in	mm	lbs
50	1.97	EL-502	10.97	21.59	6.46	8.43	1.42	4.92	2.80	Tr 95 x 4	33
	3.94	EL-504	10.97	43.19	8.43	12.36	1.42	4.92	2.80	Tr 95 x 4	44
	5.91	EL-506	10.97	64.78	10.39	16.30	1.42	4.92	2.80	Tr 95 x 4	55
	7.87	EL-508	10.97	86.38	12.36	20.24	1.42	4.92	2.80	Tr 95 x 4	66
	9.84	EL-5010	10.97	107.97	14.33	24.17	1.42	4.92	2.80	Tr 95 x 4	77
	11.81	EL-5012	10.97	129.56	16.30	28.11	1.42	4.92	2.80	Tr 95 x 4	88
95	1.97	EL-1002	20.57	40.47	7.36	9.33	1.73	6.50	2.80	Tr 130 x 6	66
	3.94	EL-1004	20.57	80.95	9.33	13.27	1.73	6.50	2.80	Tr 130 x 6	85.8
	5.91	EL-1006	20.57	121.42	11.30	17.20	1.73	6.50	2.80	Tr 130 x 6	105.6
	7.87	EL-1008	20.57	161.89	13.27	21.14	1.73	6.50	2.80	Tr 130 x 6	123.2
	9.84	EL-10010	20.57	202.37	15.24	25.08	1.73	6.50	2.80	Tr 130 x 6	140.8
	11.81	EL-10012	20.57	242.84	17.20	29.02	1.73	6.50	2.80	Tr 130 x 6	160.6
140	1.97	EL-1502	31.16	61.31	8.23	10.20	1.73	8.07	5.12	Tr160 x 6	116.6
	3.94	EL-1504	31.16	122.61	10.20	14.13	1.73	8.07	5.12	Tr160 x 6	145.2
	5.91	EL-1506	31.16	183.92	12.17	18.07	1.73	8.07	5.12	Tr160 x 6	171.6
	7.87	EL-1508	31.16	245.22	14.13	22.01	1.73	8.07	5.12	Tr160 x 6	202.4
	9.84	EL-15010	31.16	306.53	16.10	25.94	1.73	8.07	5.12	Tr160 x 6	228.8
	11.81	EL-15012	31.16	367.83	18.07	29.88	1.73	8.07	5.12	Tr160 x 6	257.4
185	1.97	EL-2002	43.93	86.44	9.57	11.54	1.97	9.25	5.12	Tr185 x 6	182.6
	5.91	EL-2006	43.93	259.31	13.50	19.41	1.97	9.25	5.12	Tr185 x 6	259.6
	9.84	EL-20010	43.93	432.19	17.44	27.28	1.97	9.25	5.12	Tr185 x 6	336.6
250	1.97	EL-2502	56.25	110.68	9.80	11.77	2.20	10.83	5.91	Tr 215 x 6	255.2
	5.91	EL-2506	56.25	332.05	13.74	19.65	2.20	10.83	5.91	Tr 215 x 6	358.6
	9.84	EL-25010	56.25	553.42	17.68	27.52	2.20	10.83	5.91	Tr 215 x 6	462
300	1.97	EL-3002	70.09	137.92	11.61	13.58	2.36	12.20	5.47	Tr 240 x 6	380.6
	5.91	EL-3006	70.09	413.76	15.55	21.46	2.36	12.20	5.47	Tr 240 x 6	512.6
	9.84	EL-30010	70.09	689.61	19.49	29.33	2.36	12.20	5.47	Tr 240 x 6	644.6
400	1.97	EL-4002	88.66	177.21	13.19	15.16	2.76	13.78	6.26	Tr 265 x 6	552.2
	5.91	EL-4006	88.66	531.62	17.13	23.03	2.76	13.78	6.26	Tr 265 x 6	719.4
	9.84	EL-40010	88.66	886.03	21.06	30.91	2.76	13.78	6.26	Tr 265 x 6	886.6
500	1.97	EL-5002	113.18	222.71	14.76	16.73	3.15	15.75	7.05	Tr 305 x 6	807.4
	5.91	EL-5006	113.18	668.13	18.70	24.61	3.15	15.75	7.05	Tr 305 x 6	1027.4
	9.84	EL-50010	113.18	1113.56	22.64	32.48	3.15	15.75	7.05	Tr 305 x 6	1249.6
600	1.97	EL-6002	132.51	260.74	15.55	17.52	3.35	16.93	7.64	Tr 330 x 6	983.4
	5.91	EL-6006	132.51	782.23	19.49	25.39	3.35	16.93	7.64	Tr 330 x 6	1238.6
	9.84	EL-60010	132.51	1303.72	23.43	33.27	3.35	16.93	7.64	Tr 330 x 6	1496
800	1.97	EL-8002	180.36	354.90	17.91	19.88	3.94	19.88	8.82	Tr 385 x 6	1564.2
	5.91	EL-8006	180.36	1064.69	21.85	27.76	3.94	19.88	8.82	Tr 385 x 6	1916.2
	9.84	EL-80010	180.36	1774.49	25.79	35.63	3.94	19.88	8.82	Tr 385 x 6	2268.2
1000	1.97	EL-10002	224.98	442.71	19.49	21.46	4.33	22.05	9.80	Tr 430 x 6	2092.2
	5.91	EL-10006	224.98	1328.12	23.43	29.33	4.33	22.05	9.80	Tr 430 x 6	2514.6
	9.84	EL-100010	224.98	2213.54	27.36	37.20	4.33	22.05	9.80	Tr 430 x 6	2937