

MICRO ONE TOUCH METRIC PLASTIC PUSH-IN FITTINGS

Male Studs

PART NO	D1	R	A	B	C	H
PC03-M3C	3	M3x0.5	3	15	9.7	8
PC03-M5C	3	M5x0.8	3.5	15	9.7	8
PC03-M6C	3	M6x1	4.5	16	9.7	8
PC04-M3C	4	M3x0.5	3	17	11.7	8
PC04-M5C	4	M5x0.8	3.5	17.5	11.7	8
PC04-M6C	4	M6x1	4.5	18	11.7	8
PC06-M5C	6	M5x0.8	3.5	21.3	13.5	10
PC06-M6C	6	M6x1	4.5	21.3	13.5	10

PART NO	D1	R	A	B	C	H
PC04-01C	4	R1/8	7.5	17	11.7	10
PC06-01C	6	R1/8	7.5	20.7	13.5	10

PART NO	D	P	R	A	B	C	H1	H2
PC04-G01C	4	9.5	G1/8	5	15	11.7	10	2.5
PC06-G01C	6	10.7	G1/8	5	17	13.5	10	4

PART NO	D	R	P	A	B	C
POC03-M3C	3	M3x0.5	8	3	15	9.7
POC03-M5C	3	M5x0.8	8	3.5	15	9.7
POC03-M6C	3	M6x1	8	4.5	16	9.7
POC04-M3C	4	M3x0.5	8	3	17	11.7
POC04-M5C	4	M5x0.8	8	3.5	17.5	11.7
POC04-M6C	4	M6x1	8	4.5	17.5	11.7
POC06-M5C	6	M5x0.8	10.5	3.5	19.8	13.5
POC06-M6C	6	M6x1	10.5	4.5	19.8	13.5

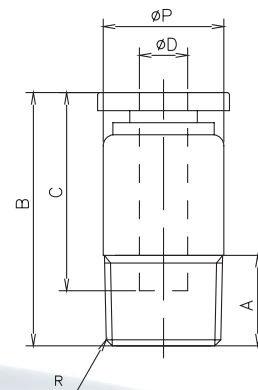
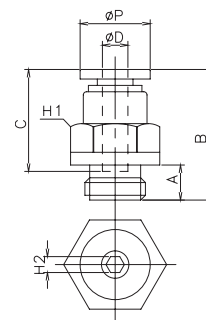
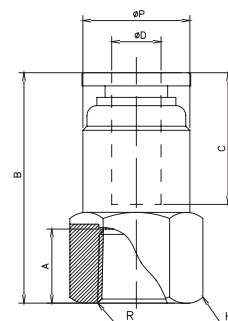
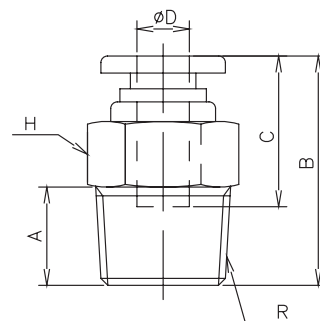

PART NO	D1	R	A	B	C	H
POC04-01C	4	R1/8	10.5	7.5	17	11.7
POC06-01C	6	R1/8	10.5	7.5	20.7	13.5

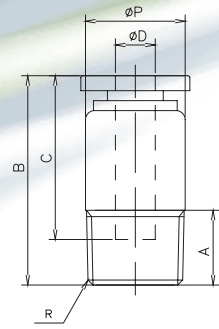

PART NO	D	P	R	A	B	C	H
POC04-G01C	4	12	G1/8	5	15	11.7	2.5
POC06-G01C	6	12	G1/8	5	17	13.5	4

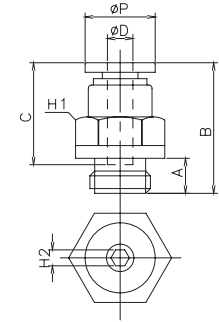

Female Studs

PART NO	D	R	P	A	B	C	H
PCF03-M3C	3	M3x0.5	7	4.5	15.7	9.7	8
PCF03-M5C	3	M5x0.8	7	5	16.2	9.7	8
PCF03-M6C	3	M6x1	7	6	17.2	9.7	8
PCF04-M3C	4	M3x0.5	8	4.5	18.2	11.7	8
PCF04-M5C	4	M5x0.8	8	5	18.7	11.7	8
PCF04-M6C	4	M6x1	8	6	19.7	11.7	8
PCF06-M5C	6	M5x0.8	10	5	20.2	13.5	10
PCF06-M6C	6	M6x1	10	6	21.2	13.5	10

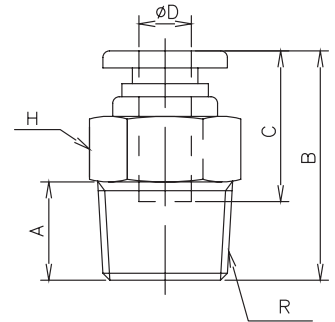

PART NO	D1	R	A	B	C	H	G
PCF04-01C	4	R1/8	8	9	22.7	11.7	12
POC06-01C	6	R1/8	10	9	22.7	13.5	12

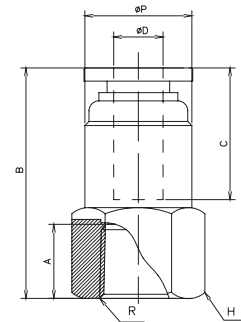

PART NO	D	R	P	A	B	C	H	G
PCF04-G01C	4	G1/8	9.5	7	22.5	11.7	12	8.5
PCF06-G01C	6	G1/8	10.7	7	22.3	13.5	12	8

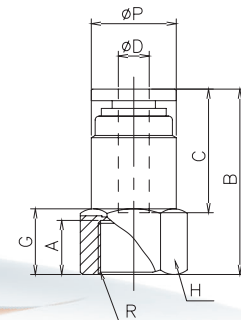

Male Elbows

PART NO	D	R	P	A	B	C	H
PL03-M3C	3	M3x0.5	7	3	14.5	12.2	8
PL03-M5C	3	M5x0.8	7	3.5	15	12.8	8
PL03-M6C	3	M6x1	7	4.5	16	12.8	8
PL04-M3C	4	M3x0.5	8.5	3	12.5	15.7	8
PL04-M5C	4	M5x0.8	8.5	3.5	13	15.7	8
PL04-M6C	4	M6x1	8.5	4.5	14	15.7	8
PL06-M3C	6	M3x0.5	10.5	3	17	16.7	10
PL06-M5C	6	M5x0.8	10.5	3.5	18	16.7	10
PL06-M6C	6	M6x1	10.5	4.5	19	16.7	10

PART NO	D	R	P	A	B	C	H
PL04-01C	4	R1/8	8.5	7.5	16.5	15.7	10
PL06-01C	6	R1/8	10.5	7.5	18.5	16.7	10

PART NO	D	P	R	A	B	C	E	H
PL04-G01C	4	9.5	G1/8	5	14.5	11.7	15.7	10
PL06-G01C	6	10.7	G1/8	5	18.5	13.5	16.7	10

PART NO	D	R	P	A	B	C	E	H
PLL03-M3C	3	M3x0.5	7	3	19.5	9.7	12.8	8
PLL03-M5C	3	M5x0.8	7	3.5	20	9.7	12.8	8
PLL03-M6C	3	M6x1	7	4.5	21	9.7	12.8	8
PLL04-M3C	4	M3x0.5	8.5	3	24	11.7	15.7	8
PLL04-M5C	4	M5x0.8	8.5	3.5	24.5	11.7	15.7	8
PLL04-M6C	4	M6x1	8.5	4.5	25.5	11.7	15.7	8
PLL06-M3C	6	M3x0.5	10.5	3	28	13.5	16.7	10
PLL06-M5C	6	M5x0.8	10.5	3.5	28.5	13.5	16.7	10
PLL06-M6C	6	M6x1	10.5	4.5	29.5	13.5	16.7	10

PART NO	D	R	P	A	B	C	E	H
PLL04-01C	4	R1/8	8.5	7.5	27.5	11.7	15.7	10
PLL06-01C	6	R1/8	10.5	7.5	30	13.5	16.7	10

PART NO	D	P	R	A	B	C	E	H
PLL04-G01C	4	9.5	G1/8	5	25.5	11.7	15.7	10
PLL06-G01C	6	10.7	G1/8	5	29.5	13.5	16.7	10

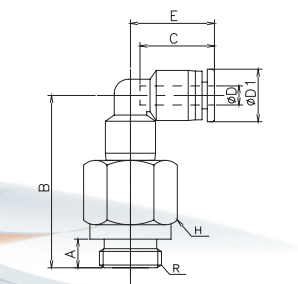
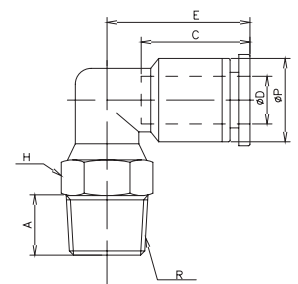
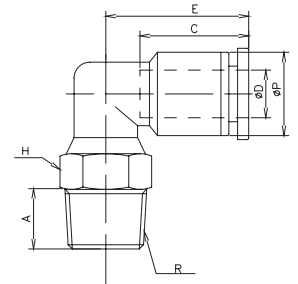
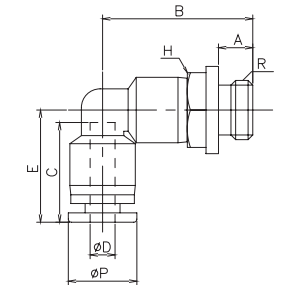
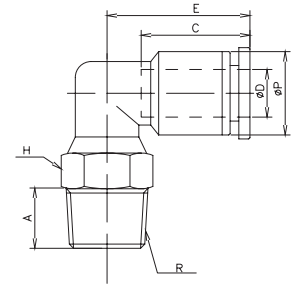
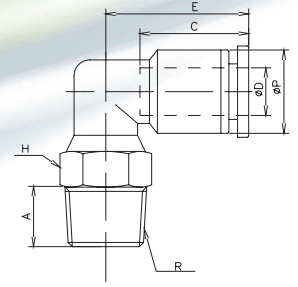

Male Tees

PART NO	D	R	P	A	B	C	E	H
PT03-M3C	3	M3x0.5	7	3	14.5	9.7	11.6	8
PT03-M5C	3	M5x0.8	7	3.5	15	9.7	11.6	8
PT03-M6C	3	M6x1	7	4.5	16	9.7	11.6	8
PT04-M3C	4	M3x0.5	8.5	3	15.7	11.7	13.8	8
PT04-M5C	4	M5x0.8	8.5	3.5	16.2	11.7	13.8	8
PT04-M6C	4	M6x1	8.5	4.5	16.7	11.7	13.8	8
PT06-M3C	6	M3x0.5	10.5	3	20.2	13.5	17.5	10
PT06-M5C	6	M5x0.8	10.5	3.5	21.2	13.5	17.5	10
PT06-M6C	6	M6x1	10.5	4.5	22.2	13.5	17.5	10

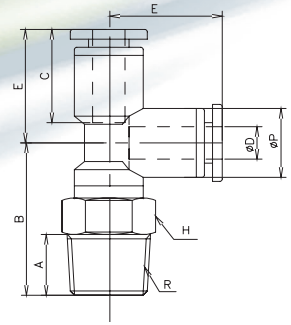

PART NO	D	R	P	A	B	C	H
PT04-01C	4	R1/8	8.5	7.5	19.2	11.7	13.8
PT06-01C	6	R1/8	10.5	7.5	21.7	13.5	17.5

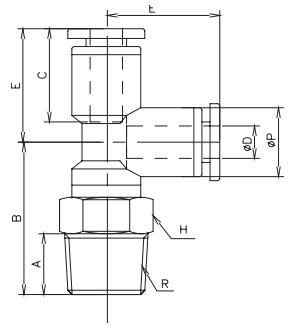

PART NO	D	R	P	A	B	C	E	F	H
PT04-G01C	4	G1/8	10	5.5	25.2	15.5	17.5	8	12
PT06-G01C	6	G1/8	12.8	5.5	26.5	15.6	19.5	8	12

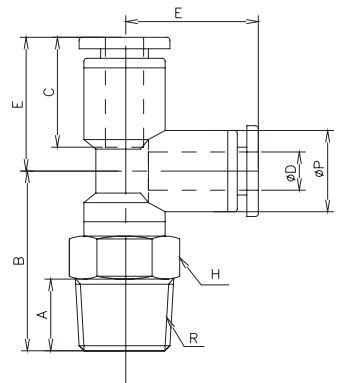

Equal Connectors

PART NO	D	P	B	C
PUC03C	3	6	18.5	9
PUC04C	4	11	31.3	14.5
PUC06C	6	13.2	34.2	15.6

PART NO	D	P	C	E	F
PUL03C	3	6	8	11	4
PUL04C	4	10	15.5	17.5	8
PUL06C	6	12.8	15.6	20.5	9.5

PART NO	D	P	C	E	F
PUT03C	3	6	10	15	4
PUT04C	4	10	15.5	17.5	8
PUT06C	6	12.8	15.6	20	9.5

PART NO	D	P	B	C	E	F
PY04C	4	10	34	15.5	10.5	15
PY06C	6	12.8	36.5	15.6	13	15.5

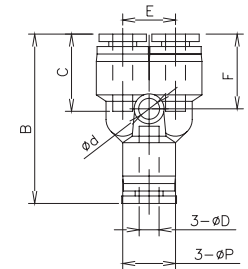
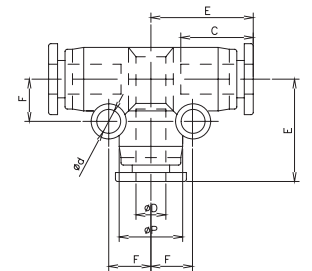
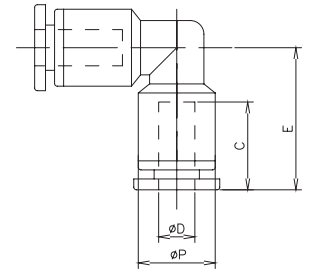
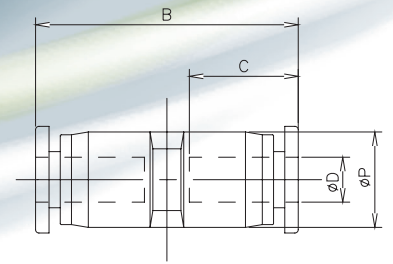

Bulkheads

PART NO	D	P	B	C	H	M
PMM03C	3	6	20.5	10	11	M10X1
PMM04C	4	10	33.5	16	14	M12X1
PMM06C	6	12.8	34.5	17	17	M14X1

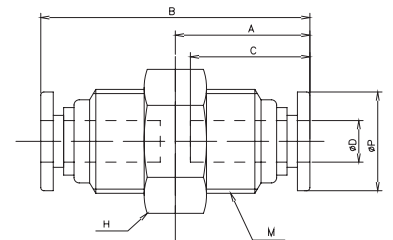

PART NO	D	P	B	C1	C2	E	H1	H2	M
PLM03C	3	6	21	8	10	12	11	13	10X1
PLM04C	4	10	36	15.5	16	17.5	14	14	12X1
PLM06C	6	12.8	40	15.6	17	20.5	17	17	14X1

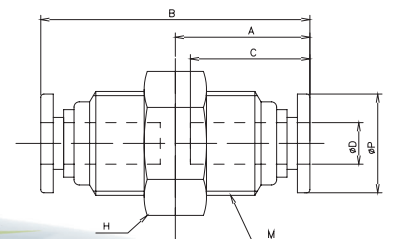

Speed Control Valves

PART NO	D	R	P	A	B	C	E	H	K
NSE03-M3C	3	M3x0.5	6	3	9	10	15	8	10
NSE03-M5C	3	M5x0.8	6	4	9	10	15	8	10
NSE03-M6C	3	M6x1	6	5	9	10	15	8	10
NSE04-M3C	4	M3x0.5	10	3	9	15.5	19.7	8	10
NSE04-M5C	4	M5x0.8	10	4	9	15.5	19.7	8	10
NSE04-M6C	4	M6x1	10	5	9	15.5	19.7	8	10
NSE06-M5C	6	M5x0.8	12.8	4	9	15.6	22.5	8	10
NSE06-M6C	6	M6x1	12.8	5	9	15.6	22.5	8	10

